

Article number: 4601906

Description: Securex torque limiter T 190/95

Measures

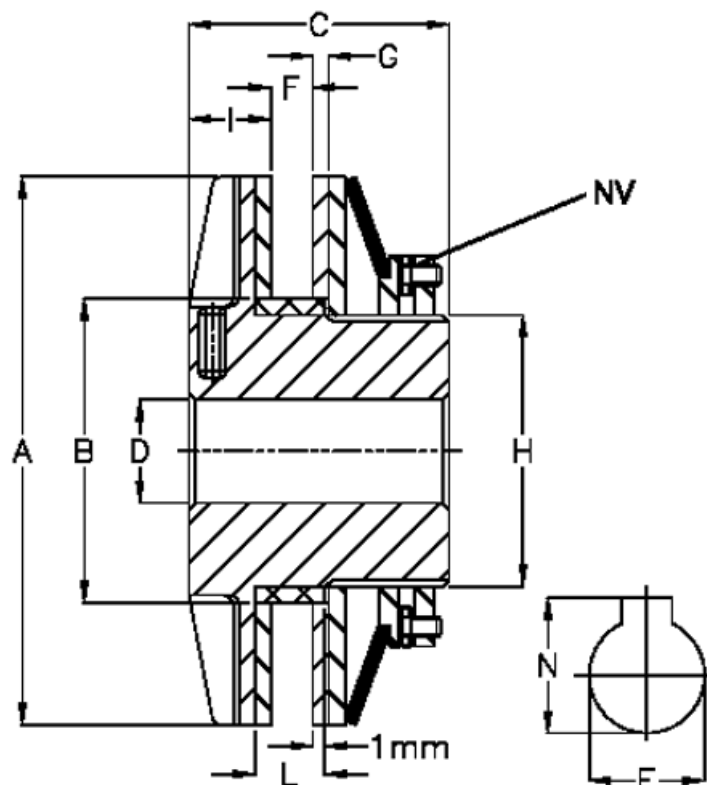

A = 95	L	= 16
B = 60	Largest possible bore with slot according to DIN 6885/1, E max = 35	
C = 66	Largest possible bore with slot according to DIN 6885/1, N	= 38.3
D = 15	Largest possible bore with slot according to DIN 6885/3, E max = 38	
F = 15	Largest possible bore with slot according to DIN 6885/3, N	= 40.8
G = 4	Max torque Nm	= 190
H = 52	Number of springs	= 1
I = 18	NV	= 13